

Article number: 03441090

Description: Fluro Rod end GE 90EC-2RS

Measures

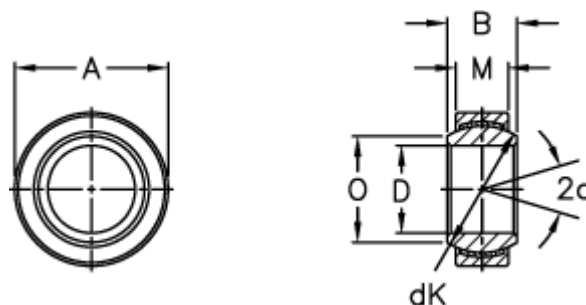

A = 130 0 -0,018

B = 60

D = 90 0 -0,020

dK = 115

Dynamic load C (kN) = 920

M = 50

O = 98.1

Static load C0 (kN) = 1840

Tilt angle = 5

Weight = 2700